

DESCRIPTION/APPLICATION

RANCO commercial pressure controls are used for either operating or protecting commercial refrigeration or air conditioning systems. They are suitable for R12, R22, and R502 refrigerants and are available with either male flare or capillary flare nut connections. Both low pressure (suction sensing) and high pressure (discharge sensing) versions are available.

These controls, with NEMA 1 enclosures and snap action switches, may be used in a variety of applications: direct control of motors or compressors; with a contactor for pilot duty control; to control solenoid valves. The electrical ratings inside the control cover must not be exceeded.

O10 Single pole, single throw (SPST)
close (cut-in) on rise
open (cut-out) on drop



O11 Single pole, single throw (SPST)
open (cut-out) on rise
close (cut-in) on drop



O16 Single pole, double throw (SPDT)
2-3 close on rise, open on drop
2-1 close on drop, open on rise

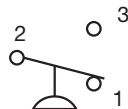

O20 Double pole, single throw (DPST)
close (cut-in) on rise
open (cut-out) on drop

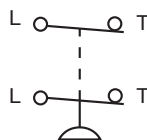

All O series are available in the automatic reset/cycling version.
Manual reset versions of the O16 are available.

DIFFERENTIAL
ADJUSTMENT
SCREW
CW increases
CCW decreases
See p. 3

RANGE
ADJUSTMENT
SCREW
CW lowers
CCW raises
See p. 3

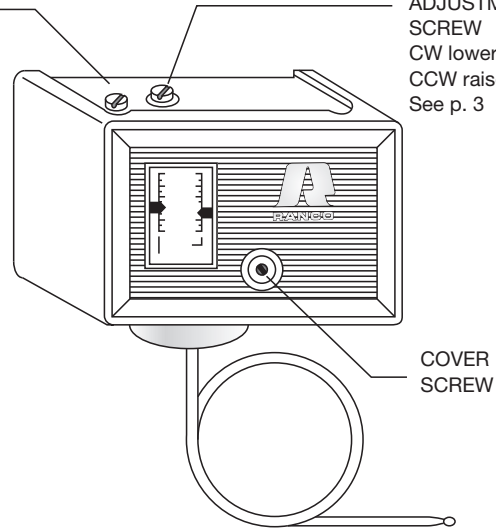

INSTALLATION

CAUTION:

To prevent possible electrical shock or equipment damage, disconnect electrical power to unit before and during installation. DO NOT restore electrical power to unit until the control is properly installed and grounded. DO NOT locate the control in an explosive atmosphere as a safety hazard can result due to possible spark generation in the control.

Controls are not to be located in areas of extreme moisture, dirt or dust, or in a corrosive or explosive atmosphere. These environments can shorten control life.

NO!

NO!

YES!

IMPORTANT NOTICE
MANUAL OPERATION (tripping switch)

The switch can be manually operated by lifting the bellows to tabs as shown. Operating the control at any other point **WILL CAUSE CONTROL DAMAGE AND VOID THE WARRANTY.**

DO NOT REMOVE the protective switch cover.

CONTROL BODY MOUNTING

Select a location that will permit proper capillary routing. It is important not to twist or strain the control body as shifting of the calibration may result.

RANCO pressure controls can be mounted in any position, either vertically or horizontally, without affecting performance. The control can be mounted on an existing bracket, on the bracket provided, or can be flush-mounted without a bracket. Whichever method is selected, use only the mounting holes provided; no other holes are to be added to the control frame.

1. Secure the control to a bracket with the 10-32 x 3/16 screws by using the two tapped holes in the back of the control.
If other mounting screws are used, they must not protrude into the control more than 1/8" to avoid damage.
2. When using the angle bracket, the control can be mounted to the compressor or any flat surface by using two or more of the four slotted holes in the base of the angle bracket.
3. When flush mounting the control, use the .20 inch holes in the back of the control frame. Access can be gained by removing the front cover and securing the control body to a wall or any flat surface.
Mounting to an uneven surface may cause improper control operation.

CAPILLARY CARE AND MOUNTING

Compressors vibrate. Copper work-hardens and fractures when flexed beyond its physical limits. Combine these two factors and broken capillaries can result. Breakage can be prevented by proper installation practices.

1. Minimize the number of times the capillary is bent. Each time it is rebent, it work-hardens making it more susceptible to breakage.
2. Avoid sharp bends, kinks, strains or pinch marks in the capillary. Never allow the capillary to rest against sharp edges or rub against metal surfaces where it can be damaged by friction.
3. The capillary should be straight within 4 inches of the pressure connection so the pulsations do not work-harden the capillary.
4. Purge all tubing and lines before connecting pressure controls.
5. Route the capillary so that it will be safe-draining to minimize

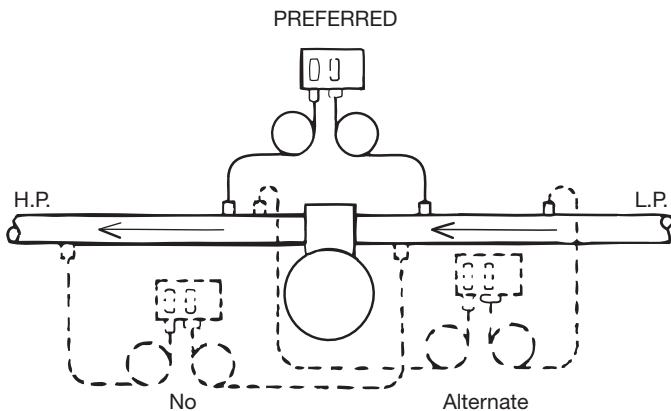

oil logging.

6. When the control is mounted directly on the compressor, the capillary must be secured to the compressor so that everything moves together. If the capillary or control is shaking or vibrating against the compressor vibration, work-hardening

COMPRESSOR MOUNTING

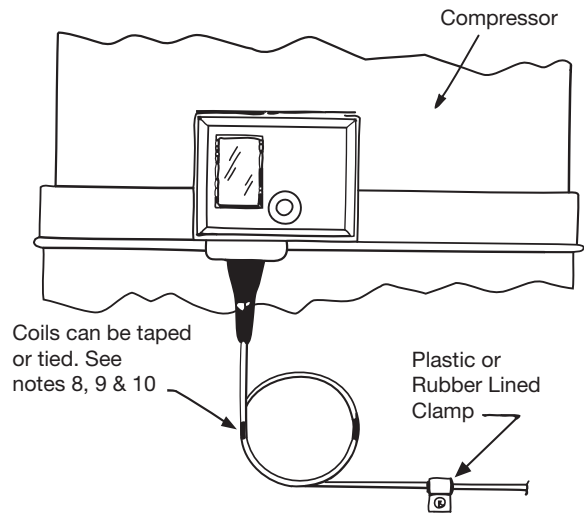

of the capillary may occur, leading to eventual failure.

7. When the control body is mounted remote from the compressor and the pressure connections are on the compressor, vibration coils must be used between the compressor and the mounted control. The coils should not touch. A section of rubber pipe insulation inserted into the vibration coils and secured with silicone adhesive will keep the coils separated, yet allow them to absorb vibration.

The capillary between the vibration coils and the control body should be secured to a stationary member when that distance

REMOTE MOUNTING

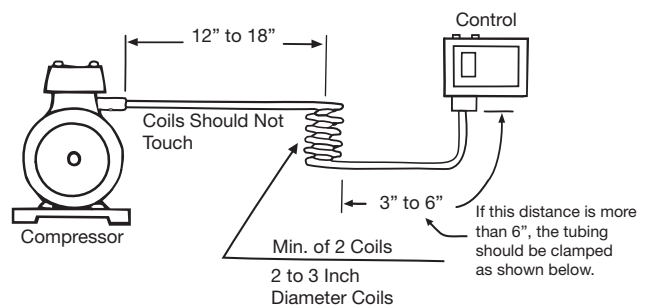

exceeds 6 inches.

The capillary between the vibration coils and the control body should be secured to a stationary member when that distance exceeds 6 inches.

REMOTE MOUNTING

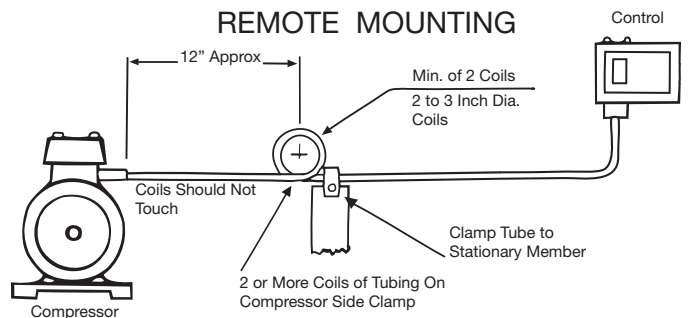

8. Coil and secure any excess capillary to avoid possible damage due to vibration. Capillary coils should be no less than 2 inches in diameter (3 inches is recommended). Silicone adhesive applied between the coils will keep them from rubbing.
9. Although coiling and securing the excess capillary is important to dampen the effects of vibration, it is just as important to allow enough slack in the capillary so that it is not taut like a “banjo string”.
10. On startup of the equipment, observe the capillary for excessive vibration and make corrections as required.

CONTROL WIRING

1. Disconnect electrical power to the unit.
2. All electrical wiring should conform to the National Electrical Code and local regulations.
3. The electrical rating inside the control cover must not be exceeded. See below for DC ratings.
4. Use copper conductors only.
5. When mounting a conduit connector to the control frame, take care to not damage the control mechanism or the hinge pin.
6. The terminals must not be bent, cut off, drilled or retapped. Electrical leads must not be taut; slack must be allowed for temperature change and vibration.
7. Attach electrical leads to the switch terminals using the screws provided (also, see below for the O16), tightened to 15-20 inch pounds.

The furnished cupwashers are to be used on the O16 when the conductor wires are directly connected to the terminals. The stripped end of the conductors should be made into a clockwise formed eye with an inside diameter to slip over the shank of the terminal screw. The cup washer, with its flanges outward, should be placed between the terminal and the screw head to capture the eye of the conductor.

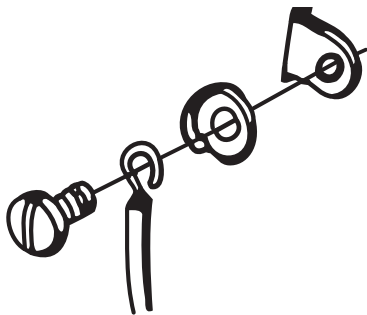

DC Rating (For AC, see inside of control cover)

	Volts	FLA	LRA	NIA	PD VA
010 and 011 with 1397004-2 magnet package installed	32	9.3	93		
	72	7.3	73		
	115	4.6	46		57.5
	230	2.3	23		57.5
020	120	4.6	46	3	57.5
	240	2.3	23	0.5	57.5
	600				57.5

CONTROL SETTINGS AND ADJUSTMENTS

ALL CONTROL SETTINGS are to be as specified by the equipment manufacturer and as required for the application. DO NOT adjust the pointers beyond the highest and lowest marks on the scaleplate. The scaleplate is only for reference and the final setting should be verified with a gauge set. As a final check, the system should be run through several cycles to assure proper settings and installation.

LOWEST EVENT: DO NOT set the control below the lowest event. On automatic reset controls, if the combination of the Range (R.H. pointer) minus the Differential (L.H. pointer) is lower than the Lowest Event, the control will not operate. See Specifications on page 4 for the Lowest Event.

LOW PRESSURE CONTROLS

Low pressure controls which are used to cut-out the compressor on pressure drop should never be set to cut-out (cut-in minus differential) lower than 20 inches of vacuum on R12; single stage R22 and R502 systems should never be set lower than 3 inches of vacuum. Excessively low settings can cause compressor damage.

Manual reset O16 low pressure controls have a scaleplate that indicates the pressure at which switch terminals 2-3 will lock open on pressure drop (DO NOT set the pointer below the Lowest Event). The pressure must rise approximately 10 PSIG above this setting before the control can be reset.

HIGH PRESSURE CONTROLS

High pressure controls which are used to cut-out the compressor on pressure rise should normally be set not higher than the values shown below:

Refrigerant Type	Cut-Out Setting	
	Air Cooled	Water Cooled
R12	230 psi	230 psi
R22	360 psi	300 psi
R502	380 psi	300 psi

Some high pressure controls are equipped with limit stops. Although the control setting can be adjusted, the limits stop prevents adjustment higher than the limit stop factory setting. DO NOT force the adjustment beyond the limit stop setting.

Manual reset O16 high pressure controls have a scaleplate that indicates the pressure at which switch terminals 2-1 will lock open on pressure rise. The pressure must drop approximately 40 PSIG below this setting before the control can be reset.

ADJUSTMENT EXAMPLES (See Control Settings and Adjustment P.3)

CLOSE ON RISE CONTROLS with Automatic reset 010 and 020; 016 terminals 2-3

The scaleplate directly indicates the **cut-in** and **differential**. The cut-out is calculated by subtracting the **differential** from the **cut-in**:

- 1) Adjust the **range** screw until the scale pointer indicates the desired **cut-in** setting.

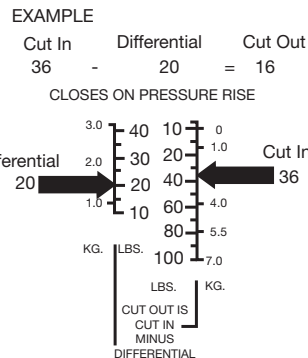

- 2) Adjust the **differential** screw until the scale pointer indicates the desired **differential** setting. The cut-out setting equals the **cut-in** setting, less the **differential**.

OPEN ON RISE with Automatic reset 011

The scaleplate directly indicated the **cut-out** and **differential**. The cut-in is calculated by subtracting the **differential** from the **cut-out**:

- 1) Adjust the **range** screw until the scale pointer indicates the desired **cut-out** setting.

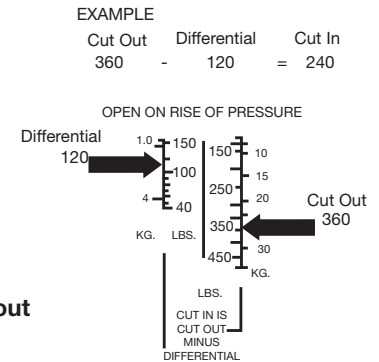

- 2) Adjust the **differential** screw until the scale pointer indicates the desired **differential** setting. The **cut-in** setting equals the **cut-out** setting, less the **differential**.

LOW PRESSURE CHECK

Low pressure controls can be preset by using a container of refrigerant and a gauge set. Use a continuity meter to indicate the closing and opening of the switch. Adjust the control to the desired settings; pressurize the control while adjusting the settings.

Low pressure settings can be rechecked when the unit is running by connecting a gauge to the section line service valve. Close the liquid line valve and allow the system to pump down, observing the low switch opening (or closing). Open the liquid line valve and

allow the pressure to increase, observing the high switch closing (or opening). Adjust the settings as necessary.

HIGH PRESSURE CHECK

High pressure control settings can be checked by selectively disconnecting various stages of fans or by blocking the air flow on air cooled condensers. On water cooled condensers, reduce or shut off the water flow while observing the cut-out and adjust as required.

CAUTION: These checks must be for a brief time only.

		SPECIFICATIONS			O10			O11		O16			O20
Pressure Range P.S.I.G. (Inches Mercury Vacuum)	Differential P.S.I.	Lowest Event P.S.I.G. (Inches Mercury Vacuum)	SPST-Opens Low			SPST-Opens High		SPDT-Opens High or Low			DPST-Opens Low		
			Male Flare	36" Capillary with Flare Nut	48" Capillary with Flare Nut	Male Flare	36" Capillary with Flare Nut	Male Flare	36" Capillary with Flare Nut	48" Capillary with Flare Nut	36" Capillary with Flare Nut		
LOW PRESSURE	(12") to 50	5 to 35	(20")	O10-1401	O10-1402	O10-1842	Use O16		O16-120	O16-557	-	O20-7002	
	(10") to 100	10 to 40	(20")	O10-1831	O10-1483	O10-1093	O11-1799	O11-3099	O16-107	O16-527	-	O20-7004	
		Manual* Reset	(20")	Use O16			Use O16		O16-585	-	O16-261	-	
HIGH PRESSURE	50 to 150	10 to 40	10	Use O16			Use O16		-	O16-166	-	-	
	100 to 250	20 to 100	0	O10-1807	-	O10-2000	Use O16		-	-	O16-593	-	
	100 to 400	40 to 150	0	O10-1894	O10-2054	-	Use O16		O16-5870	O16-108	-	O20-7006	
		17 Fixed	83	Use O16			Use O16		-	O16-142	-	-	
	150 to 450	40 to 150	0	Use O16			O11-1713	O11-1711	O16-503	-	-	-	
Manual** Reset		110	Use O16			Use O16		O16-209	-	O16-200	-		

* Locks on Pressure decrease. Pressure must rise approx. 10 PSI to be reset.

** Locks on pressure increase. Pressure must stop approx. 40 PSI to be reset.

INVENSY S

191 E. North Avenue
 Carol Stream Illinois 60188 USA
 Customer Service Telephone 1.800.304.6563
 Customer Service Facsimile 1.800.426.0804
 HVACCustomerService@Invensys.com

For Technical Service
 Telephone 1.800.445.8299
 Facsimile 1.630.260.7294
 TechnicalService@Invensys.com

Invensys™, Robertshaw®, Ranco®, and Eliwell are trademarks of Invensys plc., its subsidiaries and/or affiliated companies. All other brands mentioned may be the trademarks of their respective owners.

www.Uni-Line.com
 www.InvensysControls.com
 ©2013 Invensys
 1515064 Rev C